

ISUZU TRUCK



Whatsapp: +86 136 424 9000
+86 159 7192 0000

Water Tanker Truck



CEEC TRUCKS

Whatsapp: +86 136 4729 9000

+86 155 7197 0500
OWNER'S MANUAL

Preface

Thank you for purchasing POWERSTAR products. For better using your ISUZU water tanker truck, get the best operating performance, we strongly suggest that before the operation process you could read this manual instructions carefully, and to manipulate the program handily.

The manual detailed describes the performance of water tanker truck, structure, usage, precautions and maintenance of such knowledge. While showing details of the truck, both pictures and description will together help you get better understanding of how to use truck. Before the operation, the skilled operator should carefully read the contents of the manual.

After master the truck performance characteristics, methods of operation and precautions, then could start to operate this bucket truck. In order to ensure the staff turnover after the operation, and properly use of the truck. This manual book must be properly kept, shall not be lost and damage.

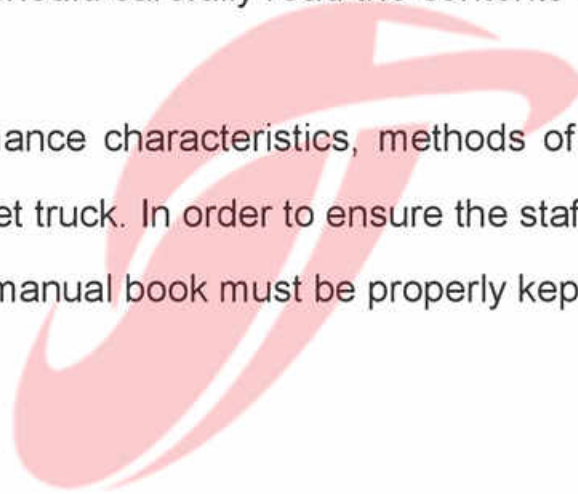

----POWERSTAR TRUCKS

CEEC TRUCKS

Whatsapp: +86 136 4729 9000
+86 159 7192 0800

Contents

| | |
|--|----|
| Chapter 1. General Description..... | 5 |
| Chapter 2, Main Technical Data | 6 |
| Chapter 3, WEILONG Water Pump..... | 7 |
| i , What is WEILONG Water Pump? | 7 |
| ii , Why choose WEILONG Water Pump? | 8 |
| iii, How to operate and maintenance WEILONG Water Pump?..... | 8 |
| Chapter 4, Water Tanker Truck Structure Components..... | 10 |
| i ,Water Tanker Structure Components..... | 10 |
| ii ,Water Pipeline Structure Components..... | 12 |
| Chapter 5, Water Tanker Truck Working Principles | 14 |
| i ,How are the water trucks working?..... | 14 |
| ii ,What is the main component for truck? | 14 |
| iii, How to operate water trucks?. (Very Important) | 15 |
| Chapter 6, Others for Attention..... | 20 |
| i ,Precautions for Use..... | 20 |
| ii ,Maintenance | 20 |
| iii, Spare Parts List..... | 21 |

Whatsapp: +86 136 4729 9000

+86 159 7192 0800

Chapter 1. General Description

*POWERSTAR TRUCKS Water Tanker Truck based on type II ISUZU 4*2 model chassis, water tanker capacity could up to 5,000liters, mainly used for water storage, transportation and spraying, and the working aerial can be city street, factory, community and other areas of need.*

*The vehicle designed to fully rely on the advantages of the original ISUZU 4*2 LHD chassis, fully consider the product's convenience and reliability. The water tanker material is international standard carbon steel, both internal and external with anti-rust painting, which can effective to avoid rusting. As for tank capacity, this can be up to 5 CBM, with front spraying nozzle & rear spraying monitor for easy operation, and can cover all customers' water transport & spraying requirement.*

*The ISUZU 4*2 Water Tanker Truck equipped with Liquidometer, rear climbing ladder, side & rear guard plate and front spraying nozzle & rear spraying monitor to help better use of the trucks. Also have rear working platform for easy operation. Therefore, the vehicle is an ideal Water Tanker Truck mainly for water transportation & water spraying.*



(Preview for your ISUZU Water Tanker Trucks)

Chapter 2, Main Technical Data

Basic parameter:

| Items | | 5 CBM ISUZU Water Tanker Truck |
|--------------------------------|------------------------------|--|
| S I Z E | Outer Dimension (L×W×H) (mm) | 5995*1870*2650 |
| | Wheelbase (mm) | 3360 |
| Kerb Weight (kg) | | 3570 |
| G E A R | Gearbox brand | ISUZU MSB |
| | Model | 5-shift gearbox |
| | Type | Manual |
| Cab capacity (includes driver) | | 2 |
| E N G I N | Model | ISUZU 4JB1CN |
| | Type | Four cylinder inline, four stroke, turbocharged Inter-cooling, diesel |
| | Rating Power (kW/HP) | 72 / 98 |
| | Emission Standard | Euro 4 |

Note: 1. The vehicle height includes Rear Climbing Ladder.

2. We keep the right to revise the parameters on the list above.

Water Tanker basic parameter list

| Items | | Parameter | |
|-----------------|--|--------------------------|-----------------------------------|
| Water tanker | Capacity (CBM) | 5 | |
| | Material | Standard Carbon Steel | |
| | Painting | Internal | With anti-rust painting |
| | | External | White painting with standard logo |
| | Special Equipment | Liquidometer | Equipped on side of tank |
| | | Valves | Equipped on side & rear of tank |
| Climbing Ladder | | Equipped at rear of tank | |
| Water Pump | Brand | WEILONG | |
| | Model | 65QZ-40/45 | |
| | Water Flow Rate | m ³ /h | 40 |
| | | l/min | 660 |
| | Lifting (m) | 45 | |
| | Self-Suction Height (m) | 6.5 | |
| | Self-Suction Capacity (min/4m) | 1.5 | |
| | Rated Power (kw) | 9.25 | |
| | More details for Water Pump showing as below | | |

Chapter 3, WEILONG Water Pump

i , What is WEILONG Water Pump?

WEILONG Pump is one of TOP Chinese brand pump. These 4 units ISUZU Water Tanker Truck use 65QZ-40/45 model water pump, the pump is newly produced National Patent Products which based on our many years' independent developing & production of self-priming centrifugal pump. Also the pump comply with national standards QC/T29114-93. Advanced features for the pump showing as below: Simple Structure, Smooth Operation, High Efficiency and Reliable Operation.

Below is basic structure for 65QZ-40/45 model water pump:

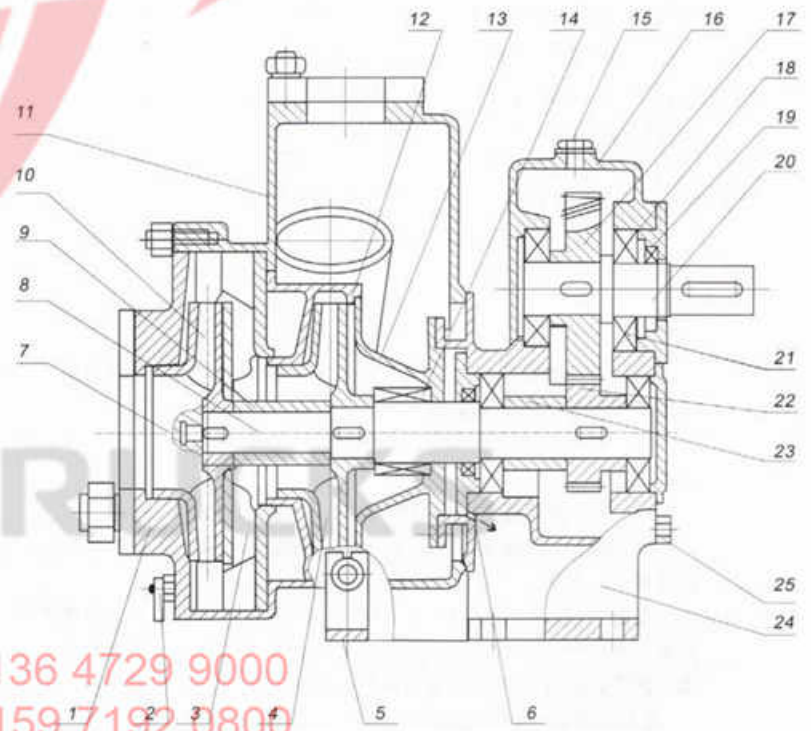
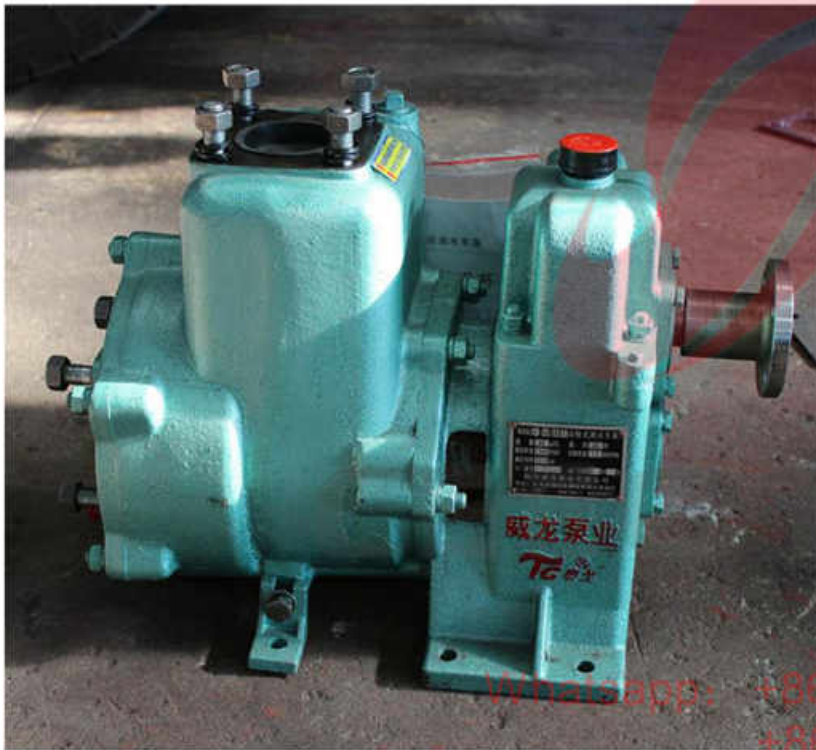

Whatsapp: +86 136 4729 9000
+86 159 7192 0800

- | | | | |
|---------------------|----------------------|-------------------------------|---------------------------|
| 1. Suction Flange | 2. Drain Valves | 3. Guide Cane | 4. Secondary Impeller |
| 5. Supporting Lug | 6. Leakage Hole | 7. Impeller Nut | 8. Pump Spindle |
| 9. Mini Axle Sleeve | 10. Primary Impeller | 11. Pump | 12. Triangle Sealing Ring |
| 13. Sealing Socket | 14. Mechanical Seal | 15. Oil-Filler Plug | 16. Gearbox |
| 17. Driving Gear | 18. Bearing | 19. Input Shaft Bearing Cover | 20. Input Shaft |
| 21. Oil Sealing | 22. Driven Gear | 23. Axle Sleeve | 24. Body |
| 25. Oil Drain Screw | | | |

ii , Why choose WEILONG Water Pump?

WEILONG brand 60QZ-40/45 model pump is specially designed water pump, and water flow rate can be up to $40\text{m}^3/\text{h}$, which is more excellent than Similar Products. Following is Performance Curve Diagram for 60QZ-40/45 model water pump:

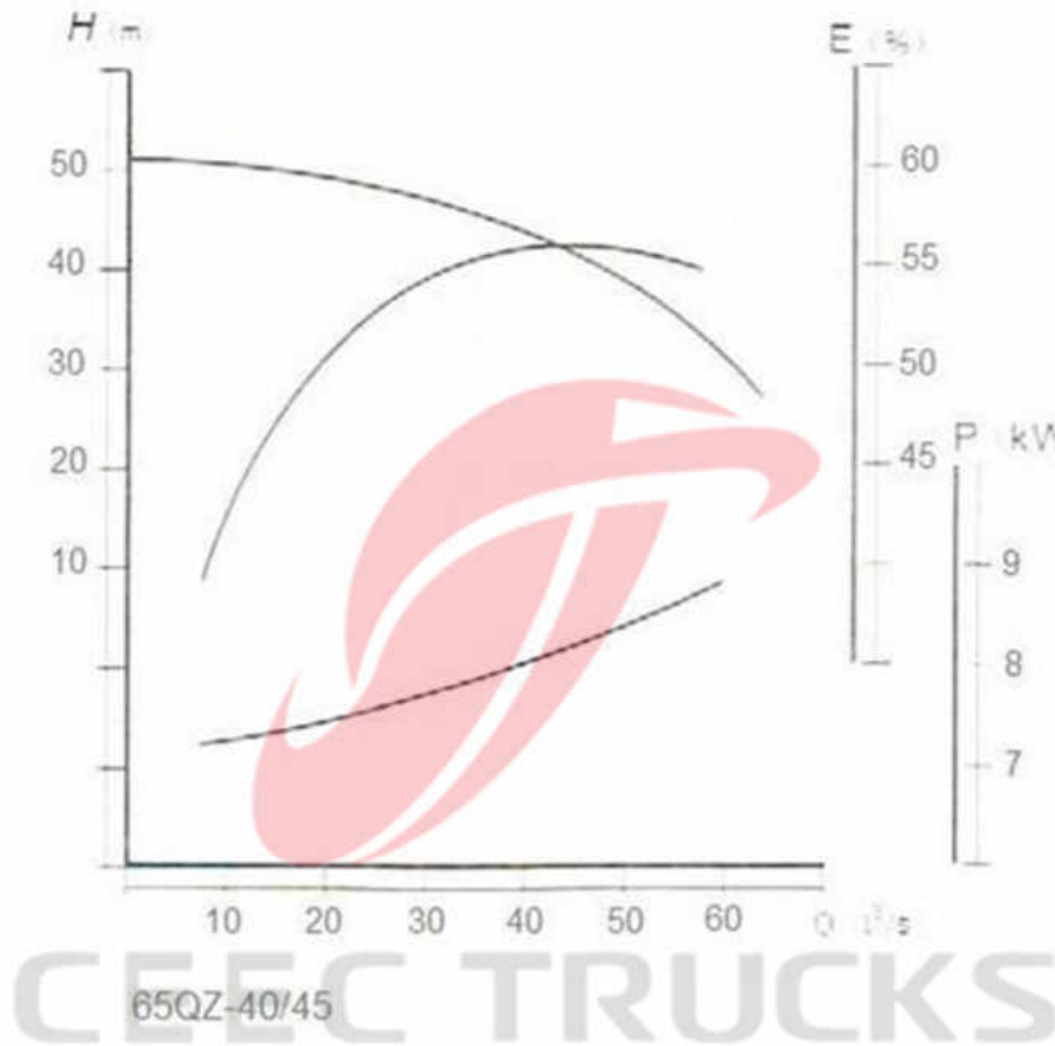

iii, How to operate and maintenance WEILONG Water Pump?

1. Before operating the WEILONG 60QZ-40/45 model water pump, first and most important thing you need to know is the pump Working Principle:

WEILONG 60QZ-40/45 model water pump internal body should have some Liquid Storage. When pump start working, the Impeller rotates and inlet valve have Negative Pressure, the air into pipeline and mixed with the liquid inside pump, then enter into Gas-Liquid Separation Chamber through Delivery Chamber. Because of density difference for water & air, air separated from liquid and discharged from outlet valve, meanwhile liquid sink in the Gas-Liquid Separation Chamber, after many times cycle operation till no air inside the suction pipeline, and then the pump can start working normally.

2. While using WEILONG 60QZ-40/45 model water pump, there are may be some unpredicted malfunction, following diagram help you better know the possible reason and solution:

| Malfunction | Possible Reason | Solution |
|--------------------------------|---|---|
| Pump Cannot Self-Priming | <ol style="list-style-type: none"> 1. There is not enough or no Liquid Storage internal of Pump 2. There is leakage for suction pipeline 3. Revolving speed too low 4. Suction Lifting too high or the inlet pipeline blocked 5. Bad airproof for pump | <ol style="list-style-type: none"> 1. Add some Liquid Storage 2. Carefully examine and eliminate the problem 3. Adjust to most suitable speed 4. Reduce lifting height or inlet pipeline length 5. Repair it or replace it |
| Not Enough Pressure | <ol style="list-style-type: none"> 1. Inlet pipeline is blocked 2. Impeller sealing ring is damaged 3. Not enough power or low revolving speed 4. Inlet or Outlet valve not fully open | <ol style="list-style-type: none"> 1. Clean up the blockage 2. Replace new sealing ring 3. Increase power and adjust to suitable speed 4. Open the valves completely |
| High Consumption for pump axle | <ol style="list-style-type: none"> 1. Flow too high 2. Revolving speed too high 3. Bearing distortion or Impeller blocked 4. Internal pipeline blocked or stuck | <ol style="list-style-type: none"> 1. Decrease the flow 2. Properly reduce the revolving speed 3. Adjust or replace new one 4. Cleaning up |
| Too Noise for pump | <ol style="list-style-type: none"> 1. Pump foot instability 2. Cavitation phenomena 3. Bearing sever wear 4. Internal pipeline in pump blocked or stuck 5. Sundries in pump or pipeline 6. Pump and PTO not same shaft | <ol style="list-style-type: none"> 1. Reinforce the pump 2. Adjust working environment 3. Replace it 4. Adjust or replace it 5. Cleaning up the pump or pipeline 6. Adjust to same shaft |

+86 159 7192 0800

Chapter 4, Water Tanker Truck Structure Components

i ,Water Tanker Structure Components

Overview for ISUZU 4*2 water tanker truck technical drawing:

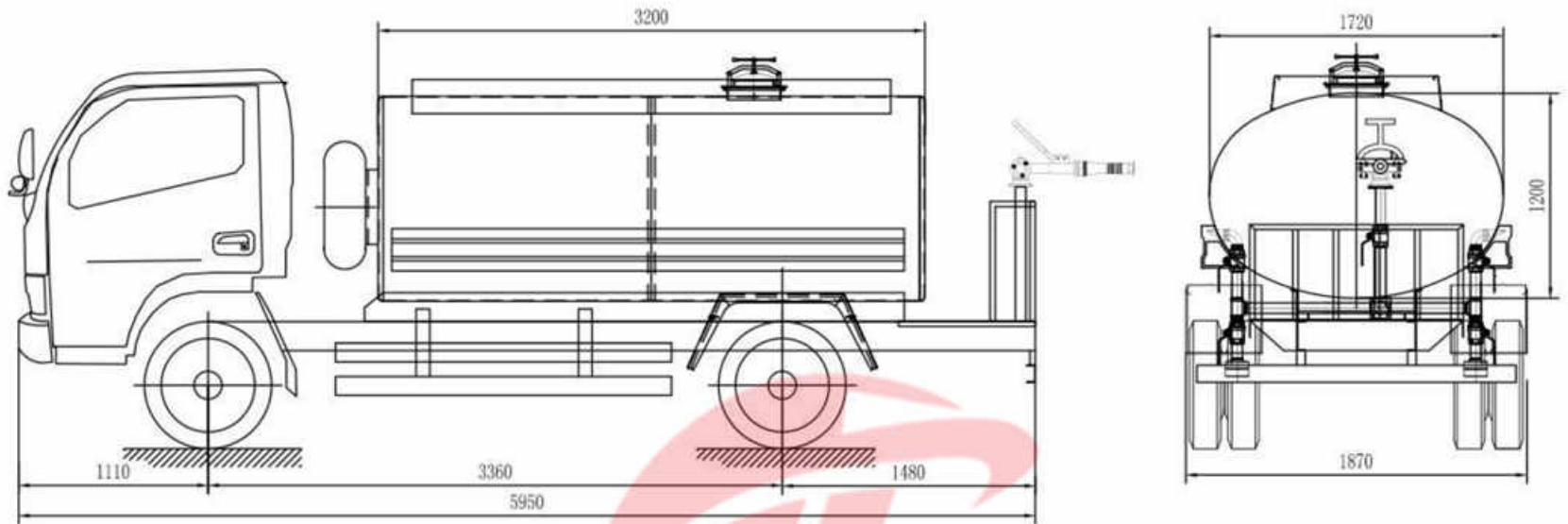

Above drawing show the water bowser dimension for reference; the tanker has one 500mm manhole for easy maintenance, rear platform for easy operation. The whole water tank is **oval shape**:

Top of the Tank: safety fence, manhole and Euro standard manhole cover

Safety fence and antiskid plate on Top of tank, for safety working



Whatsapp: +86 136 4729 9000
+86 159 7192 0800

Rear of the Tank: Climbing ladder, rotation lamp, water spraying monitor and nozzles.

Climbing ladder & Rotation warning lamp (Rear of tank)



Water Spraying Monitor

Rear Working Platform

Water Spraying Nozzles



Side of the Tank: Pipeline storage box and UQZ (Float Ball Liquid Level Indicator)

UQZ (Float Ball Liquid Level Indicator)

Pipeline storage box & nearly 3 meter long pipeline (2 sets)



Whatsapp: +86 136 4729 9000
+86 159 7192 0800

UZQ (Float Ball Liquid Level Indicator) --at diver side of water tank



Water Inlet & Outlet control valves for easy operation

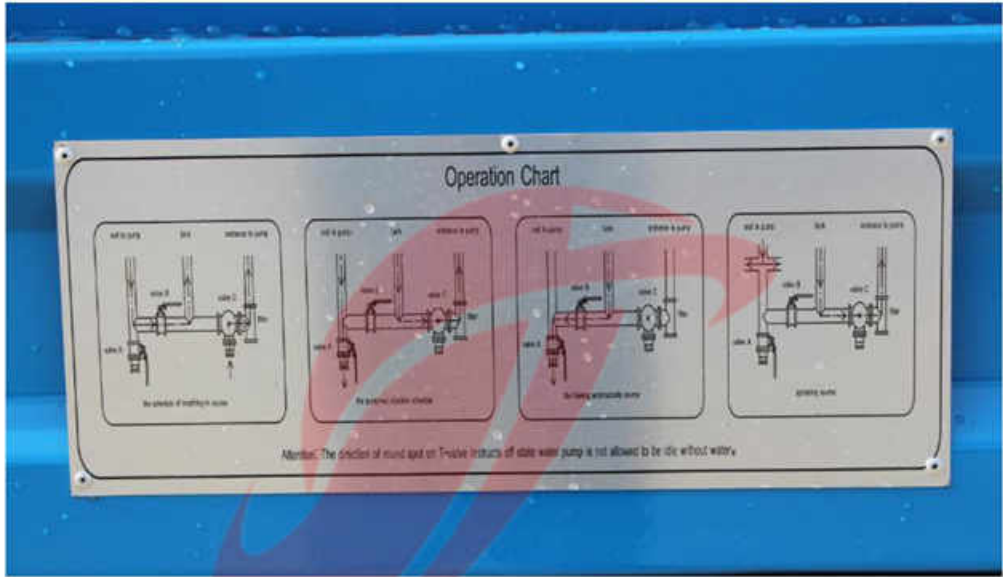

(Operation Chart for easy operation)

ii ,Water Pipeline Structure Components

CEEC TRUCKS

Pipeline is to water truck what blood vessel is to human body! The water tanker trucks pipeline system is simple but very practical. One main pipeline connect with water tank and water pump, which means there are two ways to collection water: firstly is pumping water directly through WEILONG 65QZ-40/45 pump; secondly is collection water from top Manhole.

WhatsApp: +86 136 4729 9000
+86 159 7192 0800

At side of the truck which installed WEILONG brand water pump, also DN65 inlet water valve and outlet water valve (Pipeline system as below):

WEILONG Pump
65QZ-40/45 model



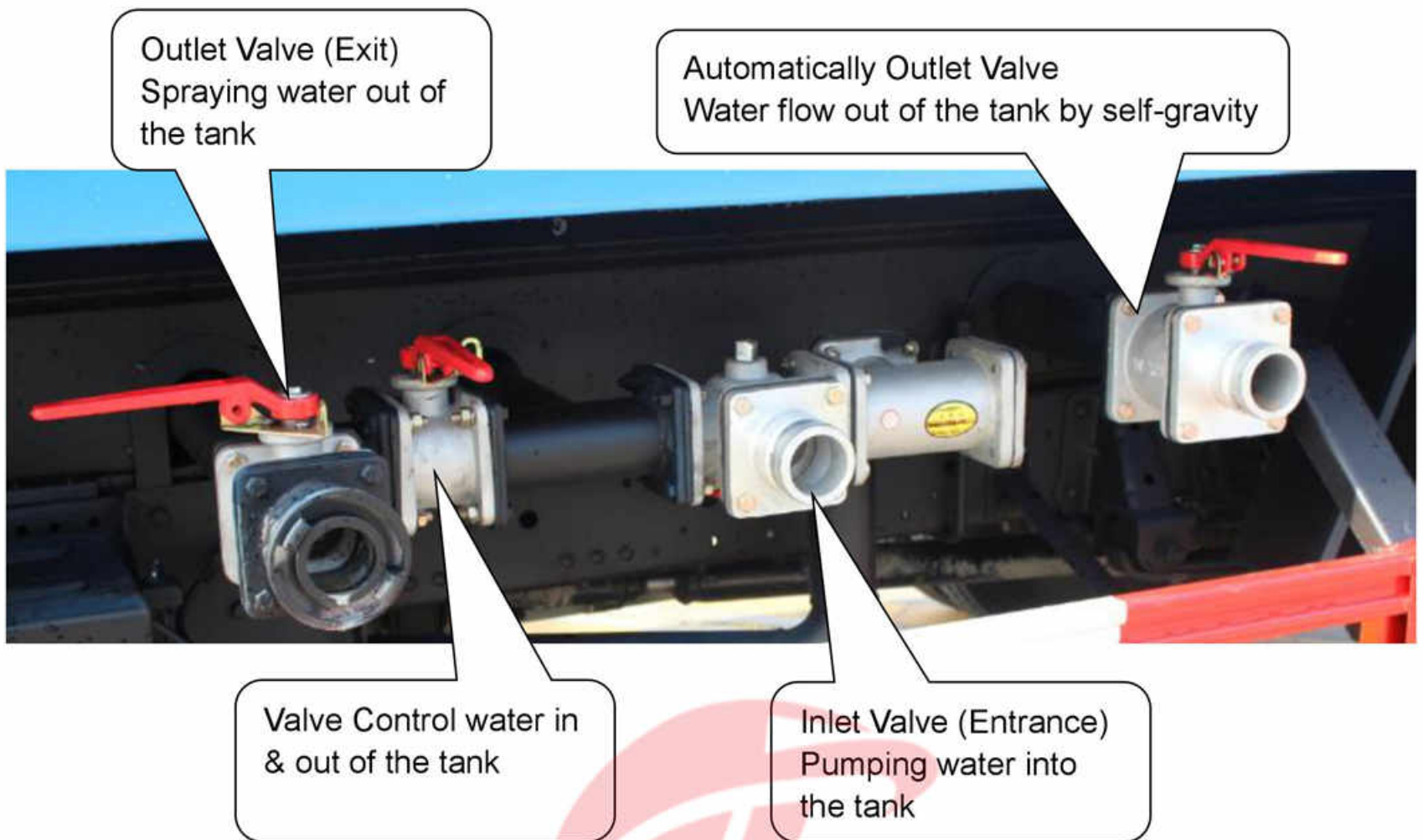

At rear of the truck which installed water platform, totally four water spraying nozzles & one water spraying monitor, also one reserved pipeline connector for necessary (Details showing as below):



Chapter 5, Water Tanker Truck Working Principles

*The operator should fully understand Whole Structure and Working Principle for ISUZU 4*2 Water Tanker Truck before any operation. Only trained person can operate this vehicle properly and to prevent unnecessary accidents and equipment damage.*

i ,How are the water trucks working?

*The ISUZU 4*2 Water Tanker Truck makes use of the special power take off (PTO) to get power from the engine, and then pass the power to the WEILONG 65QZ-40/45 pump via drive axle so to rotate the pump. The pump, pipelines valves and joints consist of the pipeline system. Turn on/off valves through the regulated program, the pump can absorb water into the tank from the source or exhaust the water inside the tank through the set lines, and then come to all function.*

ii ,What is the main component for truck?

*The water tanker truck is refitted based on the ISUZU LHD 4*2 chassis. The refit part includes water carrying assembly, actuator device, pipeline system and operation system.*

- *Water carrying assembly: A carbon steel container shaped ellipse, which is used to store work water.*
- *Actuator device: includes power take off, drive line, etc., which can pass the power from the chassis to the pump.*
- *Pipeline system helps come to all special functions, including side and rear water spraying.*
- *Operation system: helps come to all special functions' convert.*

iii, How to operate water trucks?. **(Very Important)**

1. Refer to Chapter 4 and get more information about valves structure component.

**Please Note: When wrench is PARALLEL with pipeline, the pipe flow;
When wrench is VERTICAL with pipeline, the pipe closed.**

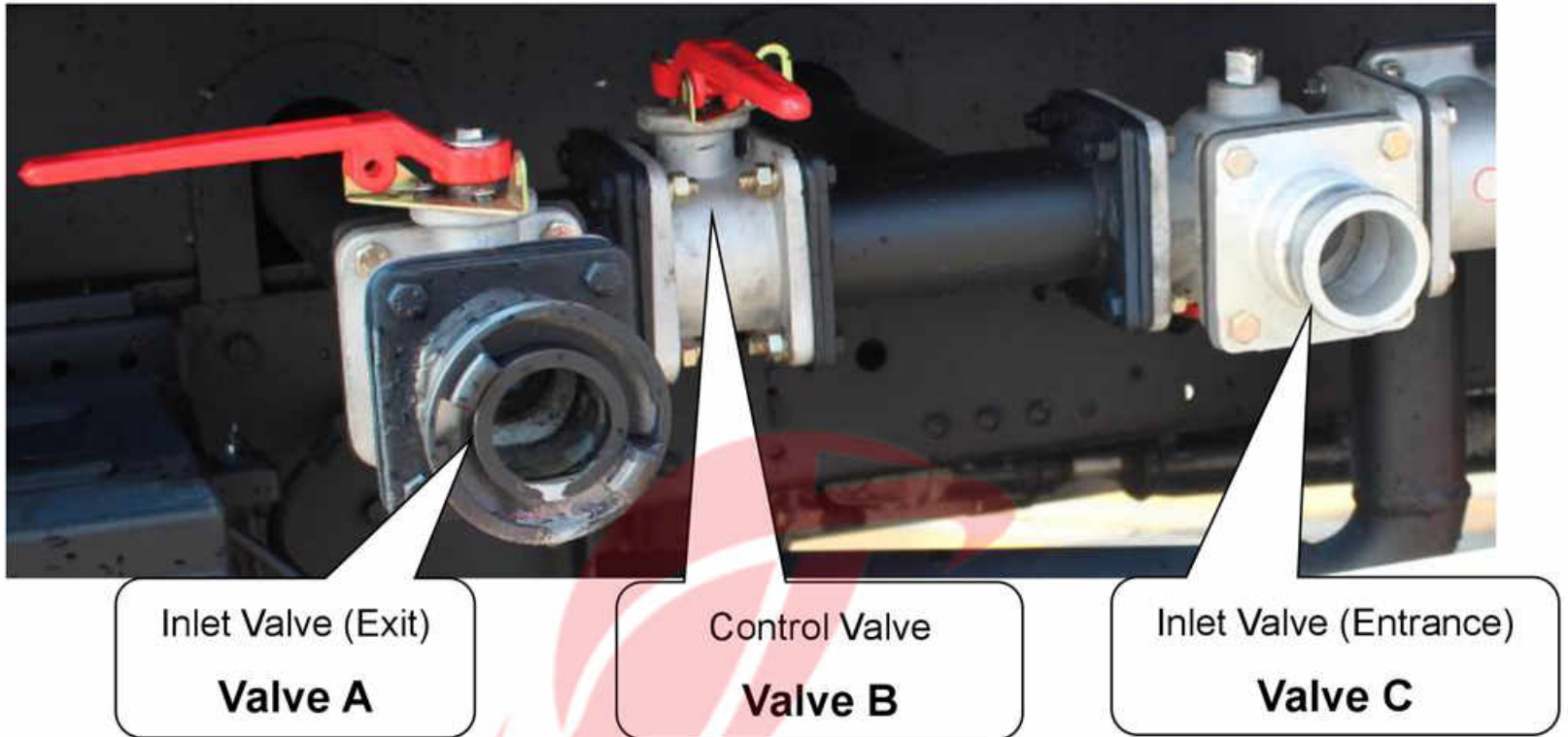

2. Read the below Operation Chart carefully before any operation:

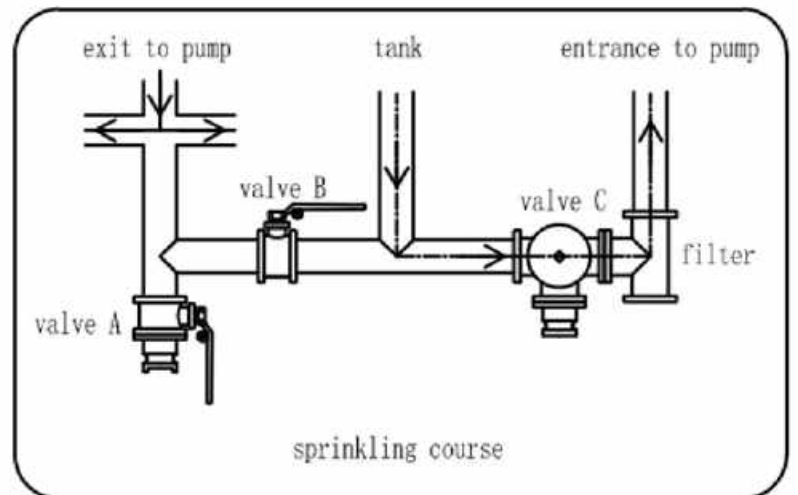
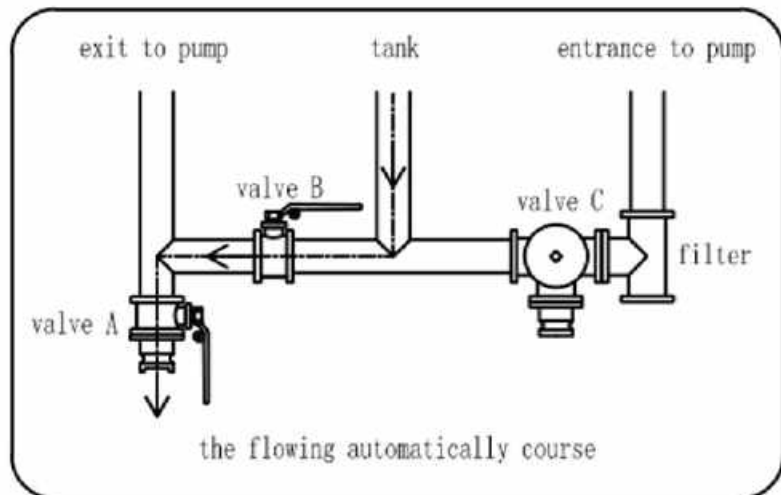
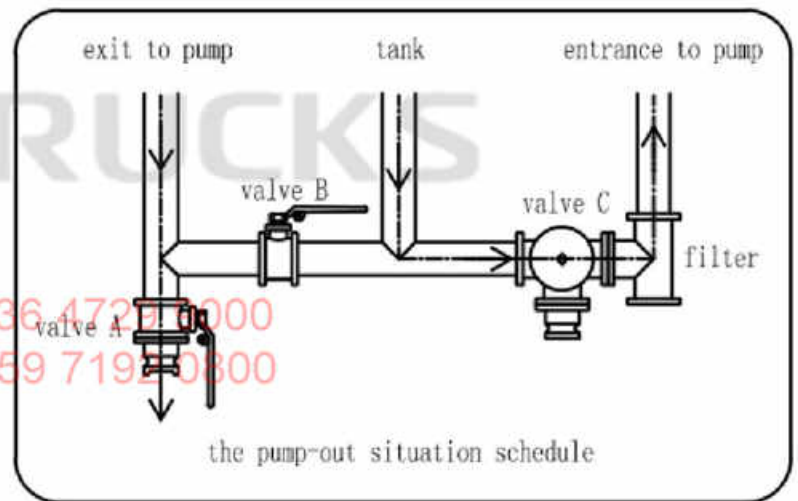
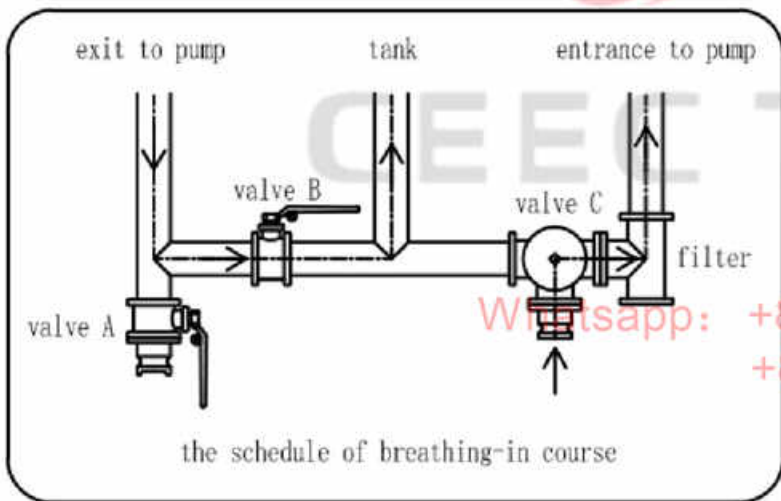

- a) Before operating valves you should operating the power take off (PTO), the truck transmission gearbox should be in neutral, when the engine is idle, step on the clutch pedal and turn the PTO switch on, and then release the clutch pedal slowly. The WEILONG pump will start operating.
- b) If this is **First Time to suction water**: You should injection at least 20Liters water into the water tank. Open the manhole cover and connect the tubes, then operation the Power Take Off and make pump working. Nearly 2 minutes later, when air exhaust out, the pump can start suction water normally.
- c) Special function operation showing as below, which mainly has following four functions:
- **Water pumping into the tank**: close Valve A, open Valve B & Valve C, make sure Valve C is RIGHT OPEN, connect the pipeline with Valve C, the other side of pipeline be in pond, river, etc, then the pump start working and water go into the tank through Inlet Valve C, details showing as below chart.

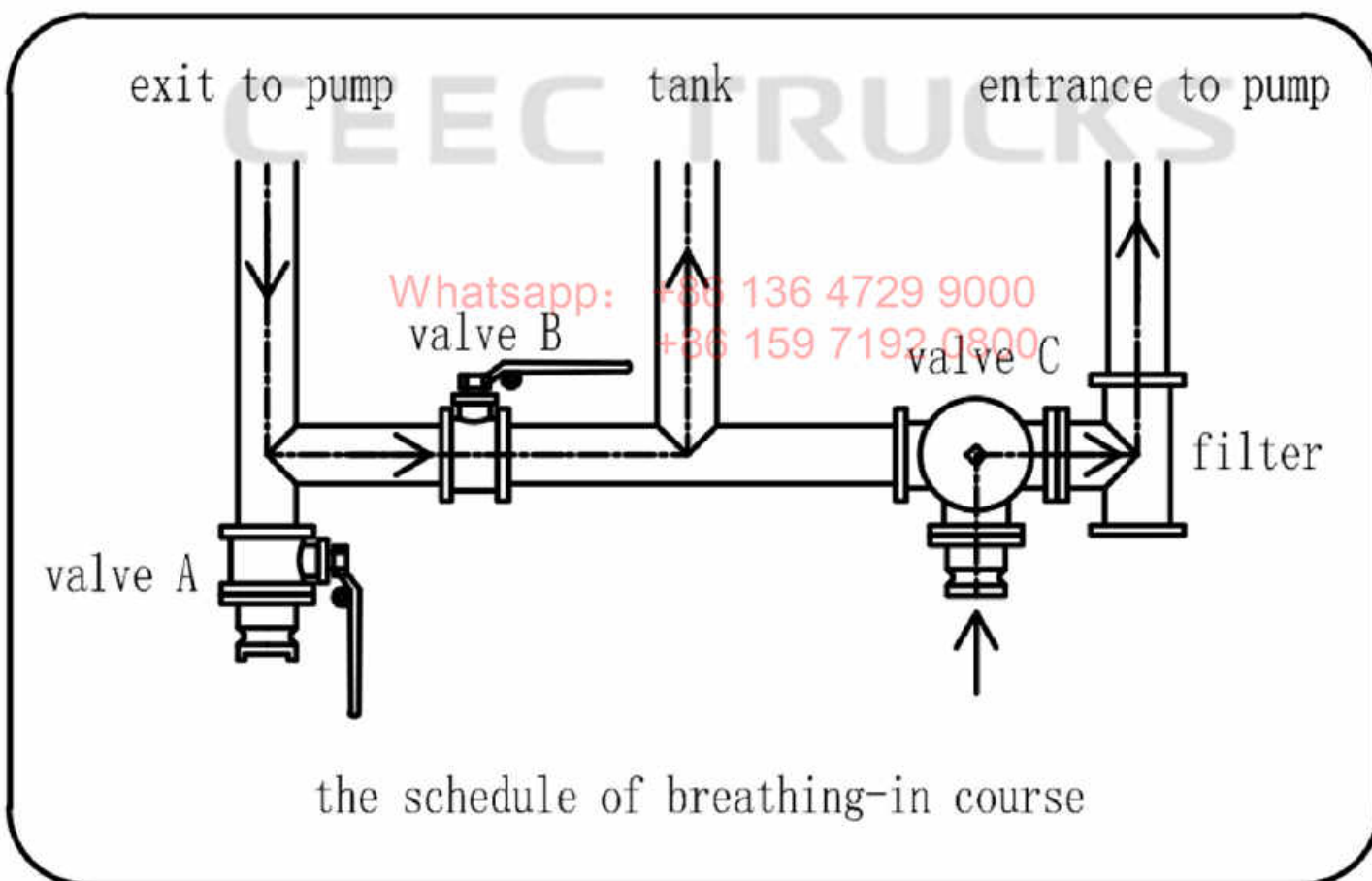

- **Water pumping out of the tank:** open Valve A, close Valve B & Valve C, then the pump start working and water go out of the tank through Outlet Valve A, details showing as below chart.

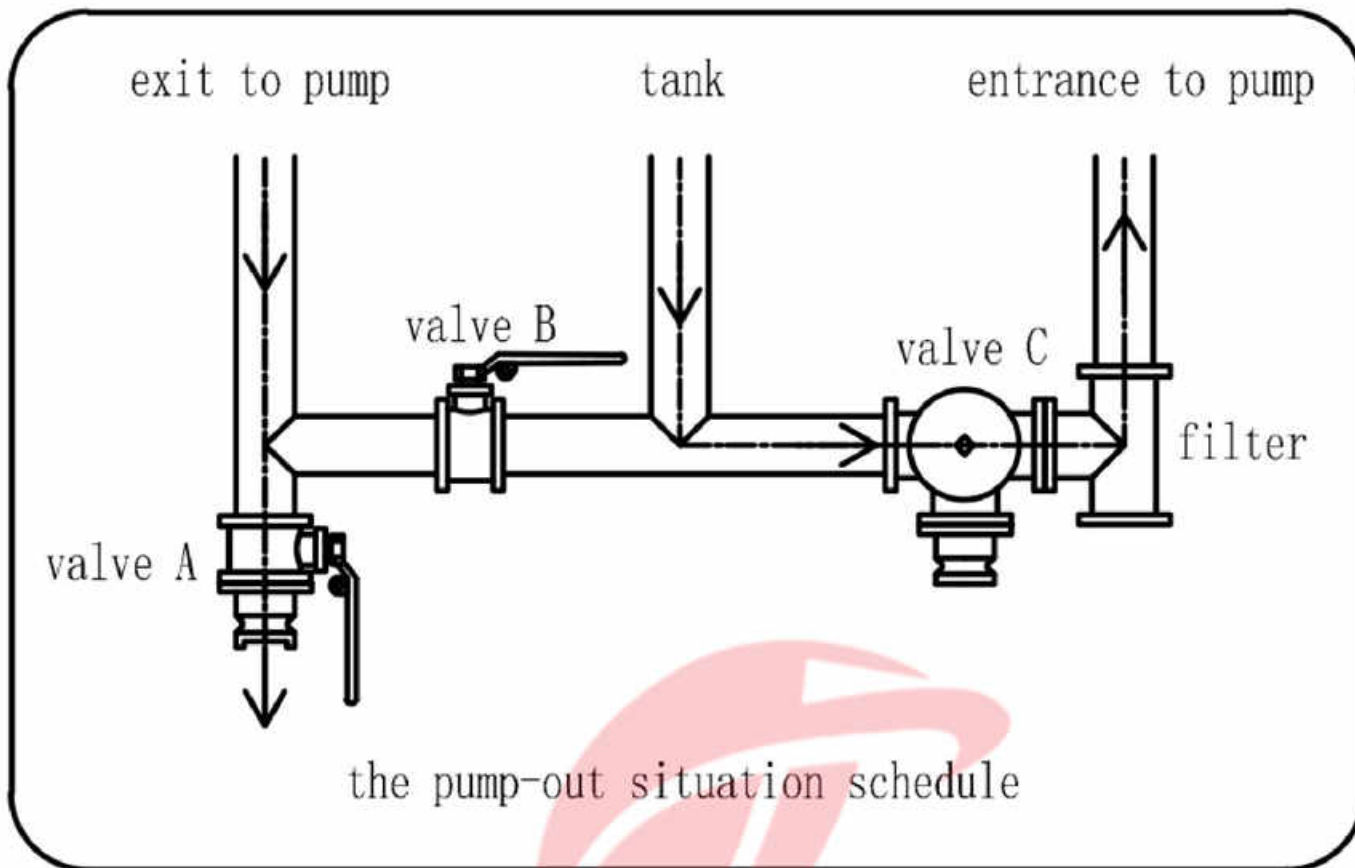

- **Water flowing out of the tank automatically (Water Pump does not work):**

Option One, close Valve C, open Valve A & Valve B, then the water flow out of the tank automatically by self-gravity, details showing as below chart.

Option Two, close Valve C, Valve A & Valve B, open Automatically Outlet Valve, then water flow out of the tank by self-gravity

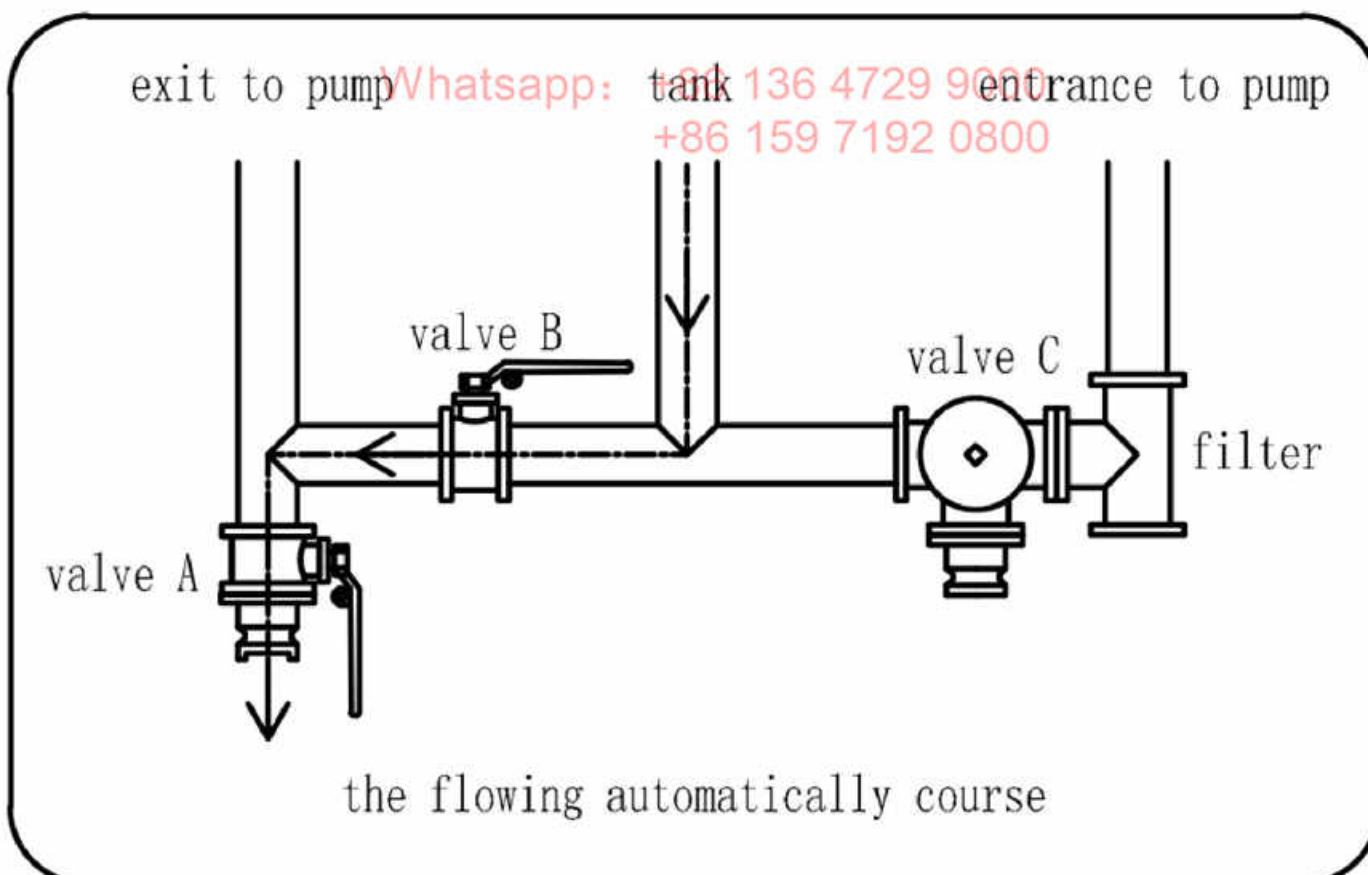

➤ **Water spraying out of the tank (Spraying from side Nozzle & rear Nozzle, also the Monitor):** close Valve A, Valve B & Valve C, then the pump start working and water pumping out of the tank, and finally spraying through side Nozzle & rear Nozzle, also the Monitor, details showing as below chart.

Make sure at least one Nozzle keeps open before operating the sprinkling course.

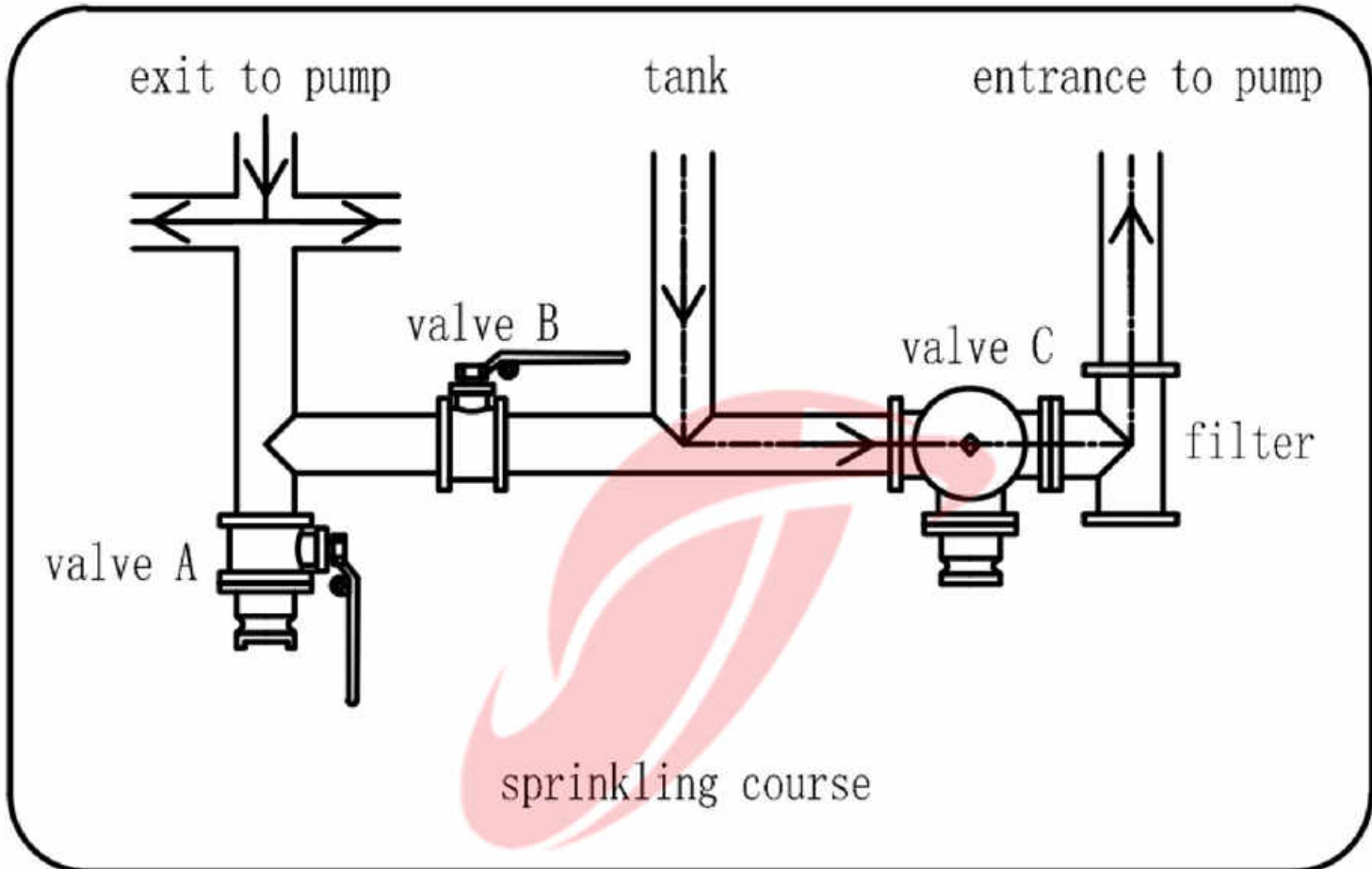

PLEASE NOTE: Each Nozzle Has One Control Valve for Easy Operation

Side Nozzle:

Whatsapp: +86 136 4729 9000
+86 159 7192 0800



Rear Nozzle:



Rear Spraying Monitor: Rotation the front control valve to choose water spraying forms



Water Spraying Form One:
Directly spraying

Whatsapp: +86 136 4729 9000
+86 159 7192 0800



Water Spraying Form Two:
Wide-Angle spraying

Chapter 6, Others for Attention

After carefully reading the above information, you must be well known how to use the ISUZU 4*2 Water Tanker Truck; below show some parts you need to pay attention while using the truck.

i ,Precautions for Use

- Please abide strictly by the following manual:
 1. **Water Tanker Truck Owner's Manual**
- It is strictly forbidden to operate the pump without water. When the pump working over 2 minutes without water, you should stop the pump and carefully check everything and find the reason. (Referring to Chapter 3: WEILONG Water Pump)
- It is strictly forbidden to operate the Power Take Off (PTO) under the condition of the clutch not separation (Not step the clutch pedal). When release the clutch, you should slowly. The operation of the PTO must only on the condition of neutral for clutch.
- It is better not to do Half-Load transportation.
- When operating the Three-Way Valves (Valve A, B, C & others), it is not good to overexert, for overexert will influence the valve ball's leakproofness. The open & close for Three-Way Valves should completely, and strictly forbidden working when valves not operated completely.

ii ,Maintenance

- The maintenance of the Water Pump refer to the **"Water Tanker Truck Owner's Manual"**.
- When the temperature is below 0 °C, the storage water inside of the Pump, Pipeline and Tank should exhaust out to protect the parts from damage. If unused for a long time, please also exhaust out the water. When use truck again after long time, you should carefully check every parts.

- *It should be checked all coupling and lubrication at fixed period to exclude the tight parts, and make sure all parts in good lubrication condition.*
- *Both the Water Pump, PTO, Transmission Gearbox should be carefully washed, checked and maintenance every year.*
- *The strainer inside filter should be washed every time after use it.*

iii, Spare Parts List

| Item | Products Name | Quantity |
|------|----------------------------|----------|
| 1 | 3 m long Pipeline | 2 units |
| 2 | Standard Tools for chassis | 1 set |
| 3 | Three-Way Valve Wrence | 1 unit |

CEEC TRUCKS

Whatsapp: +86 136 4729 9000
+86 159 7192 0800